



CS1210N4A

主要参数 MAIN CHARACTERISTICS

$I_{T(RMS)}$	12A
V_{DRM}	800V
I_{GT}	10mA

用途

- 交流开关
- 相位控制

APPLICATIONS

- AC switching
- Phase control

产品特性

- 玻璃钝化芯片高可靠性、一致性
- 低通态电压和高浪涌电流能力
- 环保 RoHS 产品

FEATURES

- Glass-passivated mesa chip for reliability and uniform
- Low on-state voltage and High I_{TSM}
- RoHS products

封装 Package

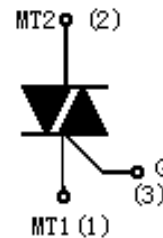

序号 Pin	引线名称 Description
1	主电极 1 MT1
2	主电极 2 MT2
3	门极 G

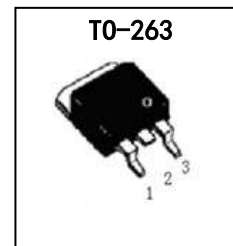
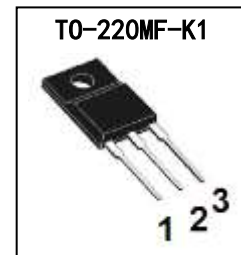
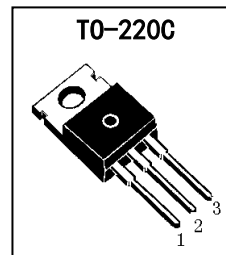

订货信息 ORDER MESSAGES

订货型号 Order codes				印 记 Marking	封 装 Package
有卤-条管	无卤-条管	有卤-编带	无卤-编带		
Halogen-Tube	Halogen-Free-Tube	Halogen-Reel	Halogen-Free-Reel		
CS1210N4A-C-B	CS1210N4A-C-BR	N/A	N/A	CS1210N4A	TO-220C
CS1210N4A-F1-B	CS1210N4A-F1-BR	N/A	N/A	CS1210N4A	TO-220MF-K1
CS1210N4A-S-B	CS1210N4A-S-BR	CS1210N4A-S-A	CS1210N4A-S-AR	CS1210N4A	TO-263

绝对最大额定值 ABSOLUTE RATINGS ($T_c=25^\circ\text{C}$)

项 目 Parameter	符 号 Symbol	试 验 条 件 Condition	数 值 Value	单 位 Unit
重复峰值断态电压 Repetitive peak off-state voltage	V_{DRM}		± 800	V
通态方均根电流 On-state RMS current	$I_{\text{T(RMS)}}$	full sine wave	12	A
非重复浪涌峰值通态电流 Non-repetitive surge peak on-state current	I_{TSM}	full sine wave ,t=20ms	95	A
		full sine wave ,t=16.7ms	105	A
		I^2t	t=10ms	45
通态电流临界上升率 Repetitive rate of rise of on-state current after triggering	dl/dt	$I_{\text{TM}}=20\text{A}$, $I_{\text{G}}=0.2\text{A}$, $dl_{\text{G}}/dt=0.2\text{A}/\mu\text{s}$	50	$\text{A}/\mu\text{s}$
峰值门极电流 Peak gate current	I_{GM}		2	A
峰值门极电压 Peak gate voltage	V_{GM}		5	V
峰值门极功率 Peak gate power	P_{GM}		5	W
平均门极功率 Average gate power	$P_{\text{G(AV)}}$	over any 20ms period	0.5	W
存储温度 Storage temperature	T_{stg}		-40~150	$^\circ\text{C}$
操作结温 Operation junction temperature	T_{VJ}		125	$^\circ\text{C}$



电特性 ELECTRICAL CHARACTERISTIC (T_C=25°C)

项 目 Parameter	符 号 Symbol	测 试 条 件 Condition		最小 Min	典型 Typ	最大 Max	单位 Unit
峰值重复断态电流 Peak Repetitive Blocking Current	I _{DRM}	V _{DM} =V _{DRM} , T _j =125°C, gate open		-	-	0.8	mA
峰值通态电压 Peak on-state voltage	V _{TM}	I _{TM} =15A		-	1.4	1.65	V
门极触发电流 Gate trigger current	I _{GT}	V _{DM} =12V, R _L =100Ω	MT1(-),MT2(+),G(+)	-	2.5	10	mA
			MT1(-),MT2(+),G(-)	-	4.0	10	mA
			MT1(+),MT2(-),G(-)	-	5.0	10	mA
			MT1(+),MT2(-),G(+)	-	11	25	mA
门极触发电压 Gate trigger voltage	V _{GT}	V _{DM} =12V, R _L =100Ω	MT1(-),MT2(+),G(+)	-	-	1.5	V
			MT1(-),MT2(+),G(-)	-	-	1.5	V
			MT1(+),MT2(-),G(-)	-	-	1.5	V
			MT1(+),MT2(-),G(+)	-	-	1.5	V
维持电流 Holding current	I _H	V _{DM} =12V, I _{GT} =0.1A		-	4.0	30	mA
擎住电流 Latching current	I _L	V _{DM} =12V, I _{GT} =0.1A	MT1(-),MT2(+),G(+)	-	3.2	25	mA
			MT1(-),MT2(+),G(-)	-	16	35	mA
			MT1(+),MT2(-),G(-)	-	4.0	25	mA
断态临界电压上升率 Rise of off- state voltage	dV/dt	V _{DM} =67% V _{DRM(MAX)} , T _j =125°C, gate open		-	50	-	V/μs

热特性 THERMAL CHARACTERISTIC

项 目 Parameter	符 号 Symbol	条 件 Condition	最小 Min	典型 Typ	最大 Max	单位 Unit
结到管壳的热阻 Thermal resistance junction to case	R _{th(j-c)}	full cycle(TO-220C/TO-263)			1.5	°C/W
		full cycle(TO-220MF-K1)			2.8	°C/W



特征曲线 ELECTRICAL CHARACTERISTICS (curves)

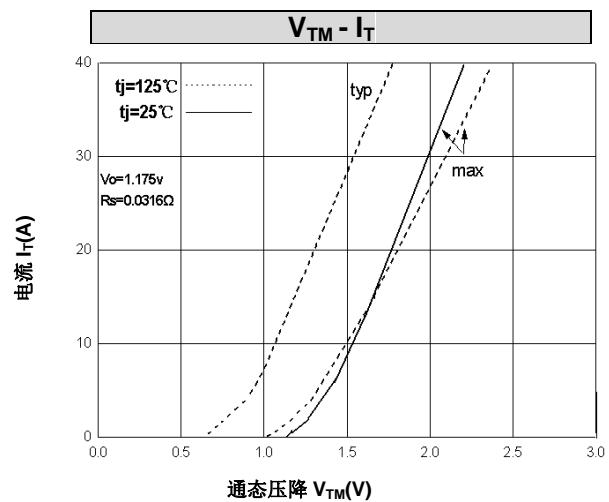
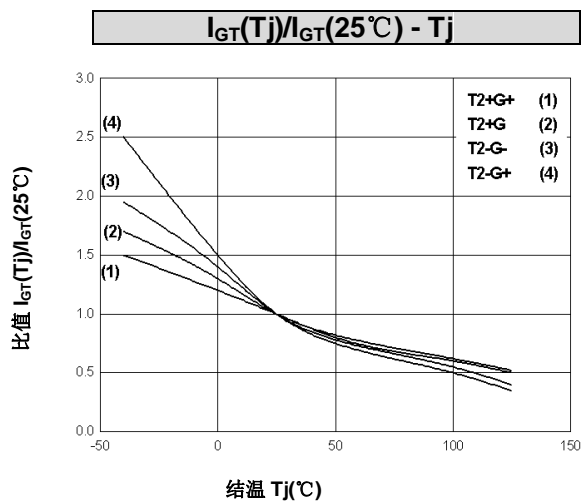
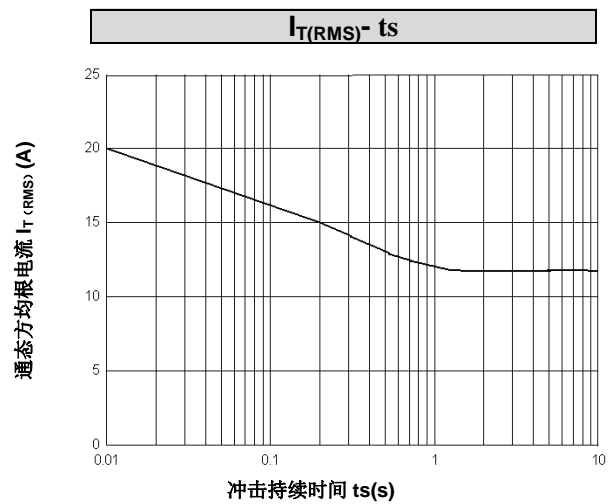
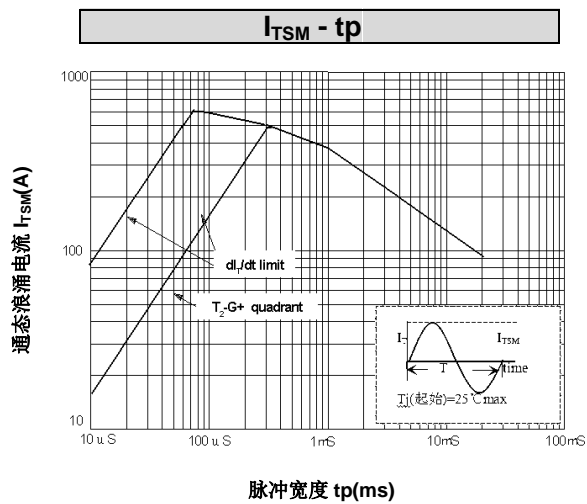
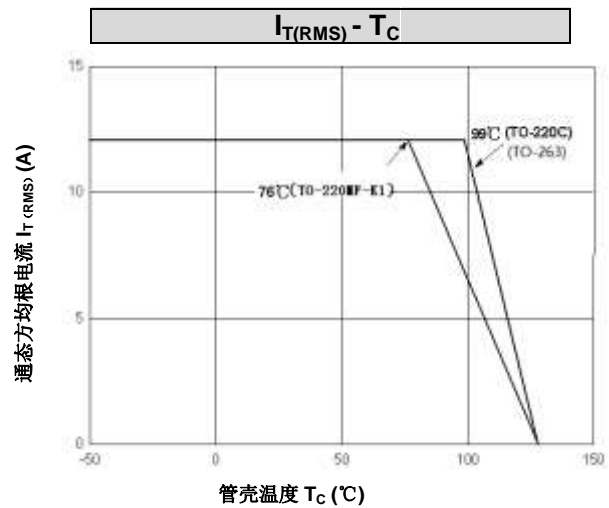
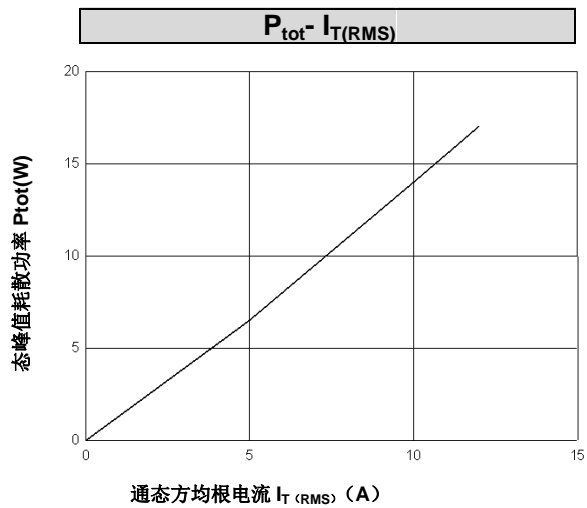



外形尺寸 PACKAGE MECHANICAL DATA

TO-220C

单位 Unit : mm

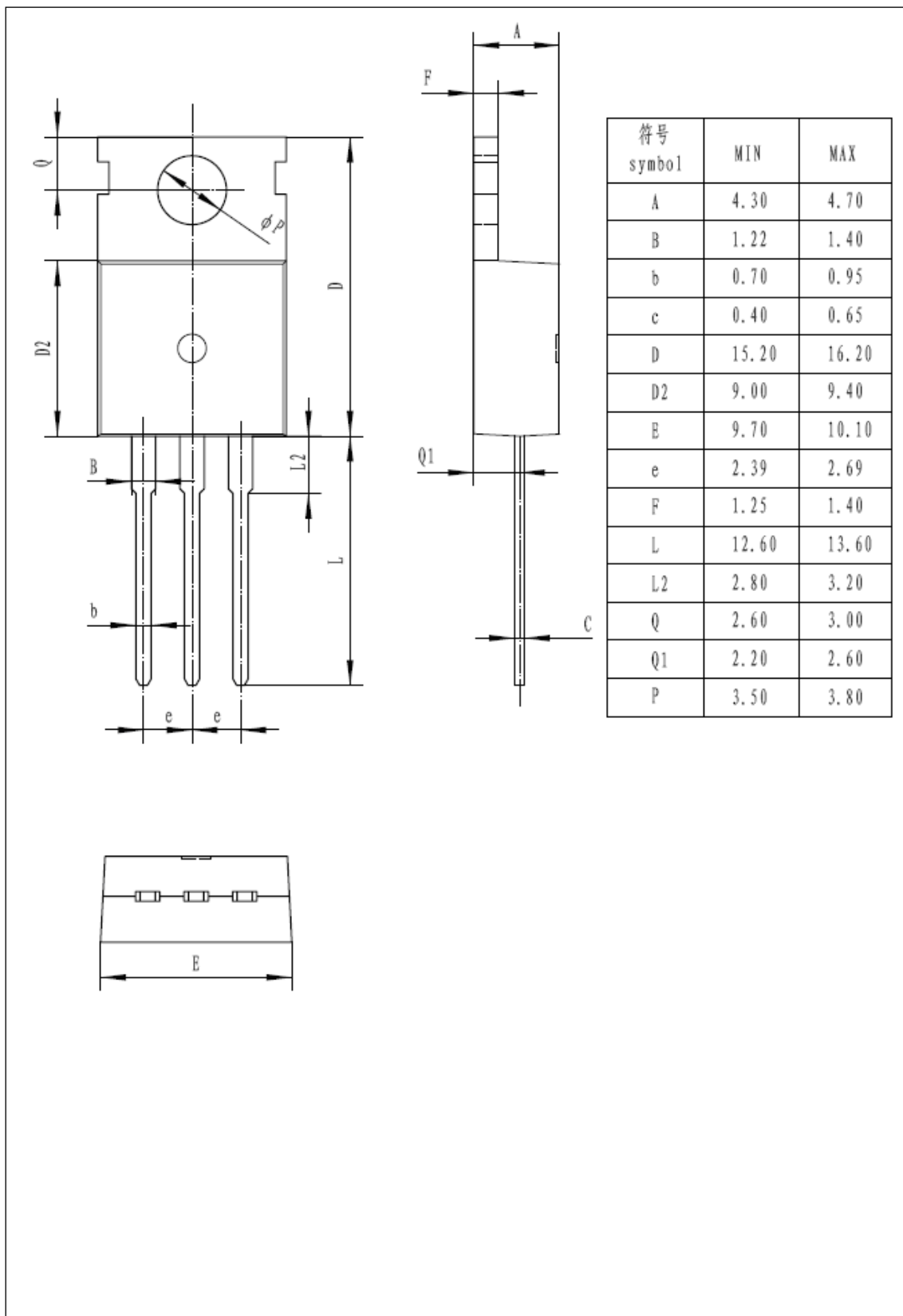



外形尺寸 PACKAGE MECHANICAL DATA

TO-220MF-K1

单位 Unit : mm

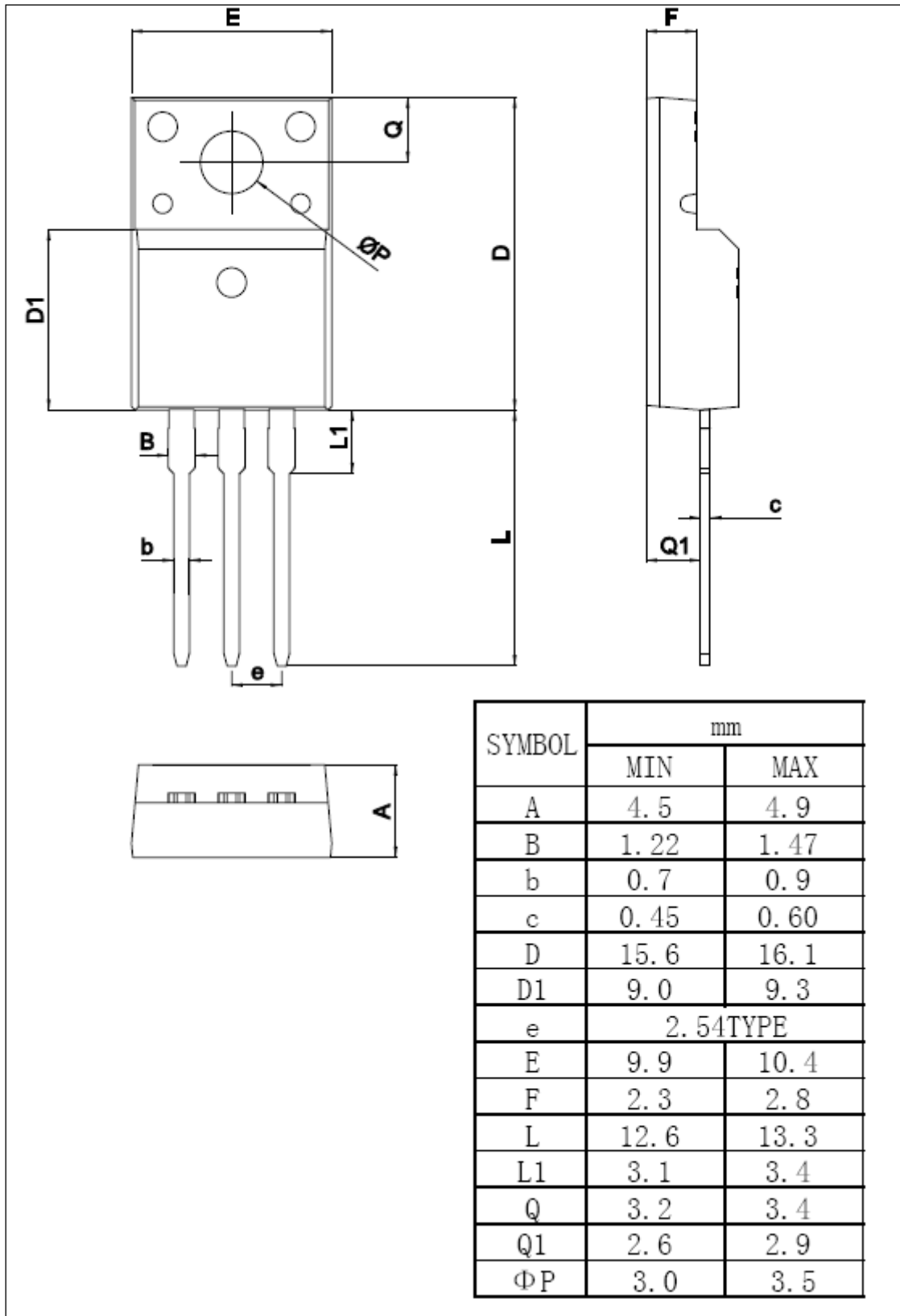



外形尺寸 PACKAGE MECHANICAL DATA

TO-263

单位 Unit : mm

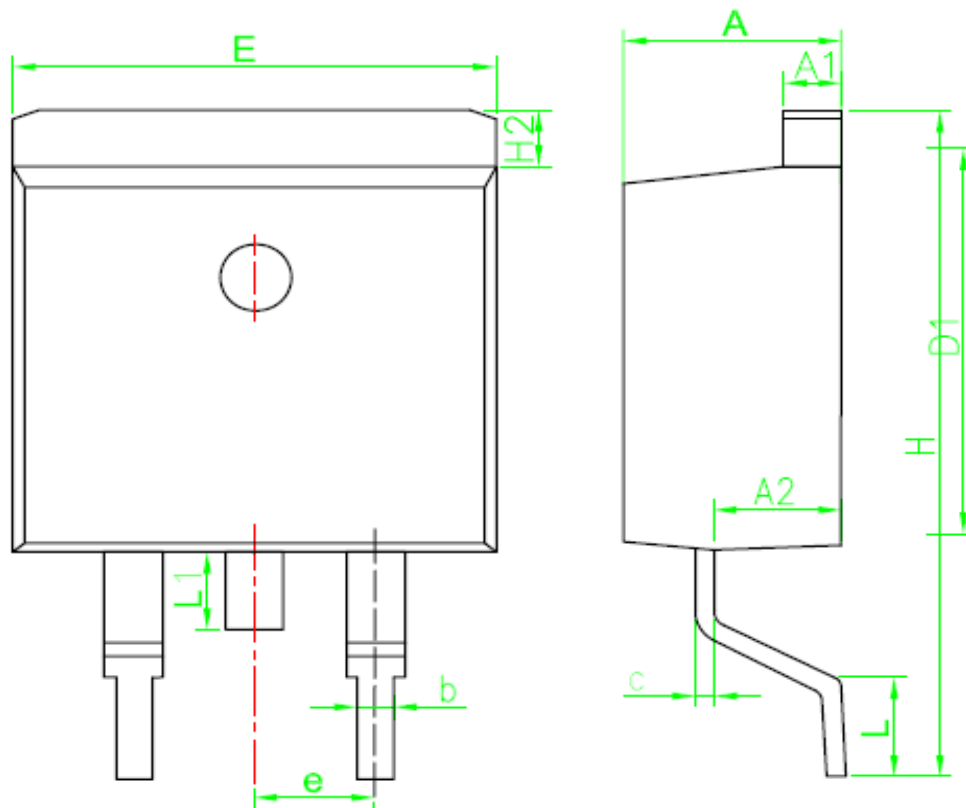

SYMBOL	MM	
	MIN	MAX
A	4.30	4.80
A1	1.12	1.42
A2	2.54	2.84
b	0.67	1.00
c	0.29	0.52
D1	8.40	9.00
E	9.80	10.46
e	2.54BSC	
H	14.00	16.00
H2	1.12	1.45
L	1.50	3.10
L1	1.45	1.70



注意事项

1. 吉林华微电子股份有限公司的产品销售分为直销和销售代理，无论哪种方式，订货时请与公司核实。
2. 购买时请认清公司商标，如有疑问请与公司本部联系。
3. 在电路设计时请不要超过器件的绝对最大额定值，否则会影响整机的可靠性。
4. 本说明书如有版本变更不另外告知。

NOTE

1. Jilin Sino-microelectronics co., Ltd sales its product either through direct sales or sales agent , thus, for customers, when ordering , please check with our company.
2. We strongly recommend customers check carefully on the trademark when buying our product, if there is any question, please don't be hesitate to contact us.
3. Please do not exceed the absolute maximum ratings of the device when circuit designing.
4. Jilin Sino-microelectronics co., Ltd reserves the right to make changes in this. specification sheet and is subject to change without prior notice.

联系方式

吉林华微电子股份有限公司

公司地址：吉林省吉林市深圳街 99 号

邮编：132013

总机：86-432-64678411

传真：86-432-64665812

网址：www.hwdz.com.cn

CONTACT

JILIN SINO-MICROELECTRONICS CO., LTD.

ADD: No.99 Shenzhen Street, Jilin City, Jilin Province, China.

Post Code: 132013

Tel: 86-432-64678411

Fax: 86-432-64665812

Web Site: www.hwdz.com.cn